

910_ZONE SLIM

design: Gianluigi Landoni



IT_Descrizione prodotto

Divani, Divani componibili, Chaises longues, Pouf

Caratteristiche tecniche

Struttura: Massello di abete e legni composti

Molleggio: Nastri elastici unidirezionali ad alta portata.

Imbottitura: Poliuretano espanso.

Cuscini seduta: Poliuretano espanso e memory a quote differenziate, ricoperto in termofalda.

Cuscini schienale: Fibra di poliestere siliconata ricoperta da fodera in cotone 100%.

Piedi: Alluminio lucido o brunito.

Rivestimento: Rivestimento in tessuto o in pelle.

Rivestimento in tessuto completamente sfoderabile.

Opzioni:

- Piedi in noce canaletto.

EN_Product description

Sofas, Unit sofas, Chaises longues, Ottoman

Technical features

Frame: Solid fir-wood and composite woods.

Springing: high resistance unidirectional elastic bands.

Padding: Polyurethane foam.

Seat cushions: Polyurethane foam and memory covered with heated bonded polyester fibre.

Back cushions: Silicone polyester fibre covered with 100% cotton lining.

Feet: Bright or finishing burnished aluminium.

Cover: Fabric or leather cover. Fabric cover completely removable.

Options:

- Canaletto walnut feet.

Piedi / Feet



_brunito
_burnished



_alluminio lucido
_bright aluminium

Opzioni / Options



_noce canaletto
_canaletto walnut

Vibieffe

SINCE 1968

contact@vibieffe.com www.vibieffe.com

910_ZONE SLIM

design: Gianluigi Landoni

- A - Memory foam / Memory foam
- B - Espanso densità portante / Foam supporting density
- C - Espanso densità soft / Foam soft density
- L - Fusto in legno / Wooden frame
- R - Resinato / Heated bonded polyester fibre
- S - Fibra poliestere / Silicone polyester fibre

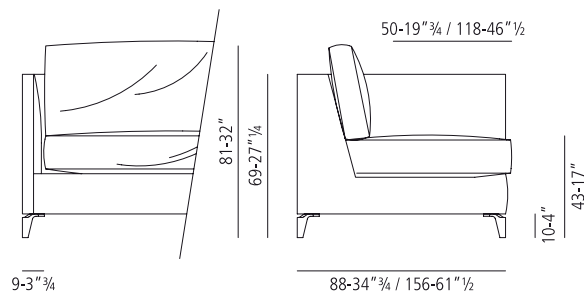
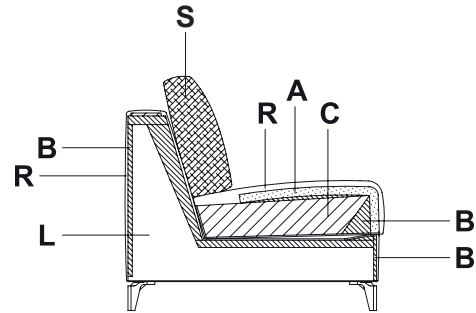

Vibieffe

SINCE 1968

contact@vibieffe.com www.vibieffe.com

910_ZONE SLIM

design: Gianluigi Landoni

cod. 910001

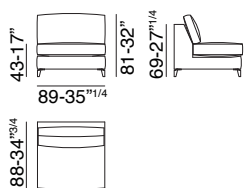

cod. 910002

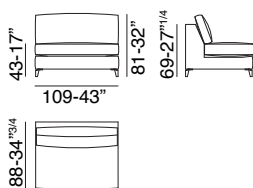

cod. 910003

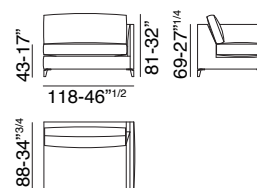

cod. 910004

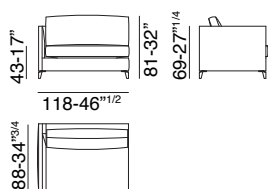

cod. 910005

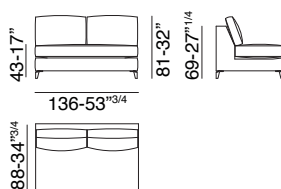

cod. 910006

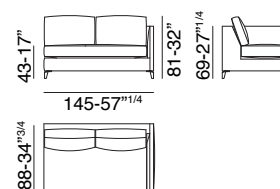

cod. 910007

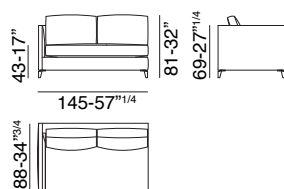

cod. 910008

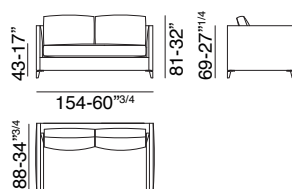

cod. 910009

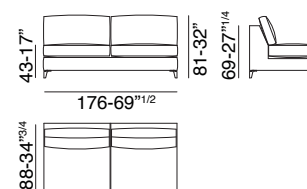

cod. 910010

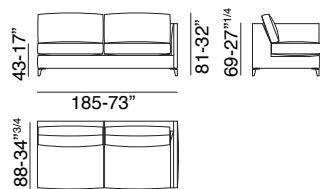

cod. 910011

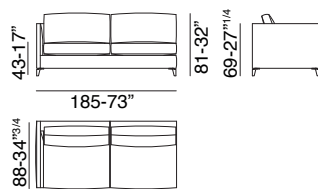

cod. 910012

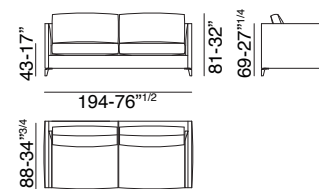

Vibieffe

SINCE 1968

contact@vibieffe.com www.vibieffe.com

910_ZONE SLIM

design: Gianluigi Landoni

cod. 910017

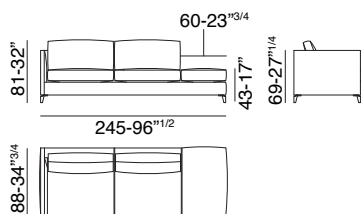

cod. 910018

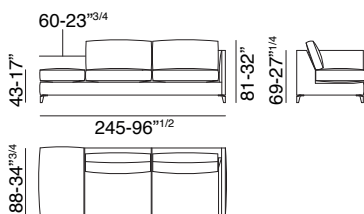

cod. 910013

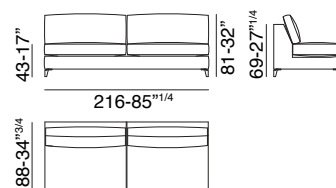

cod. 910015

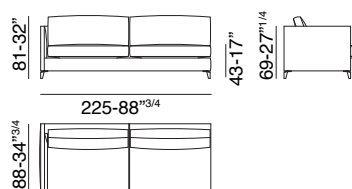

cod. 910014

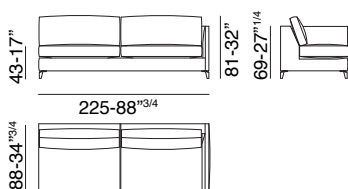

cod. 910016

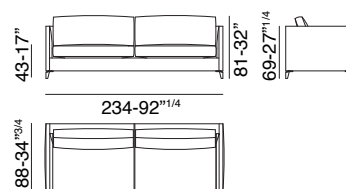

cod. 910019

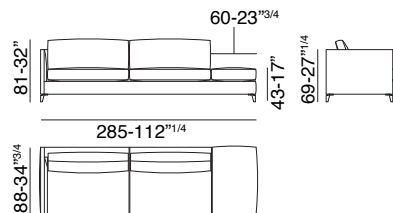

cod. 910020

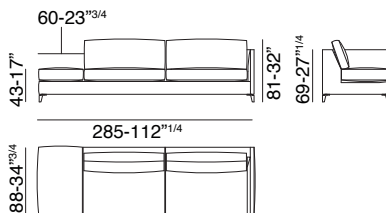

cod. 910022

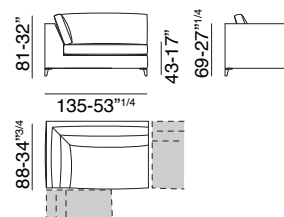

cod. 910021

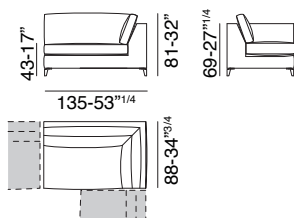

cod. 910023

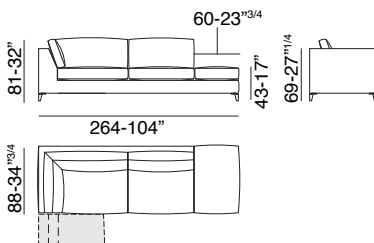

cod. 910024

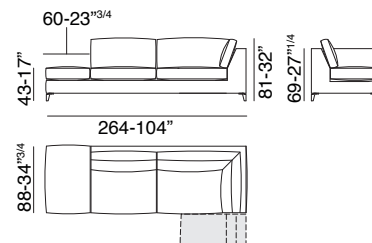

Vibieffe

SINCE 1968

contact@vibieffe.com www.vibieffe.com

910_ZONE SLIM

design: Gianluigi Landoni

cod. 910025

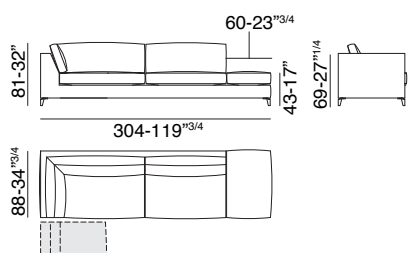

cod. 910026

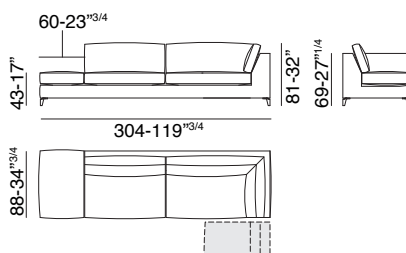

cod. 910029

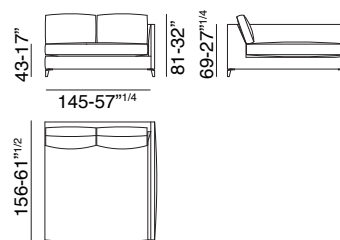

cod. 910030

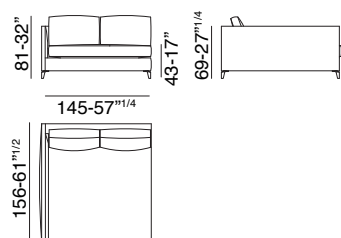

cod. 910027

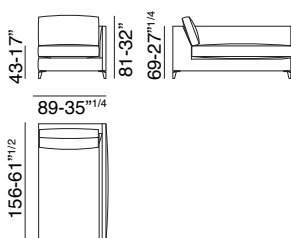

cod. 910028

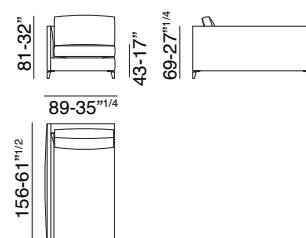

cod. 910031

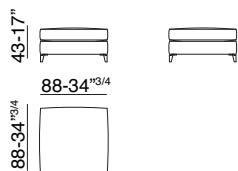

Vibieffe

SINCE 1968

contact@vibieffe.com www.vibieffe.com

910_ZONE SLIM

design: Gianluigi Landoni



Vibieffe

SINCE 1968

contact@vibieffe.com www.vibieffe.com