



## IT\_Descrizione prodotto

Divani, Divani componibili, Chaise longue, Pouf

### Caratteristiche tecniche

Struttura: Massello di abete.

Molleggio: Nastri elastici unidirezionali ad alta portata.

Imbottitura: Poliuretano espanso.

Cuscini seduta: Inserto in poliuretano espanso avvolto da materassina in piuma.

Cuscini schienale: Piuma lavata e sterilizzata con tampone interno in poliuretano espanso.

Cuscino terminale: Inserto in poliuretano espanso avvolto da materassina in piuma.

Meccanismo terminale: Reclinabile in 5 diverse posizioni.

Piedi: Tecnici neri.

Finitura: Barra anteriore in alluminio.

Rivestimento: Rivestimento in tessuto o in pelle.

Rivestimento in tessuto completamente sfoderabile.

## EN\_Product description

Sofas, Unit sofas, Chaises longues, Ottoman

### Technical features

Frame: Solid fir-wood.

Springing: High resistance unidirectional elastic bands.

Padding: Polyurethane foam.

Seat cushions: Core in polyurethane foam covered with a feather layer.

Back cushions: Core in polyurethane foam covered with a feather layer.

End element cushion: Core in polyurethane foam covered with a feather layer.

End element mechanism: Adjustable in 5 different positions.

Feet: Black standard.

Finishing: Front aluminium bar.

Cover: Fabric or leather cover. Fabric cover completely removable.

# 810\_FLY

design: Gianluigi Landoni

- B - Espanso densità portante / Foam supporting density
- C - Espanso densità soft / Foam soft density
- L - Fusto in legno / Wooden frame
- P - Piuma / Feather
- R - Resinato / Heated bonded polyester fibre

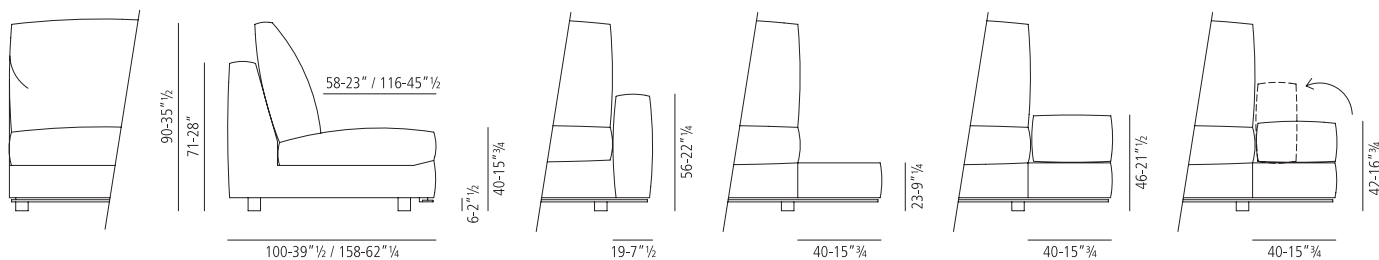
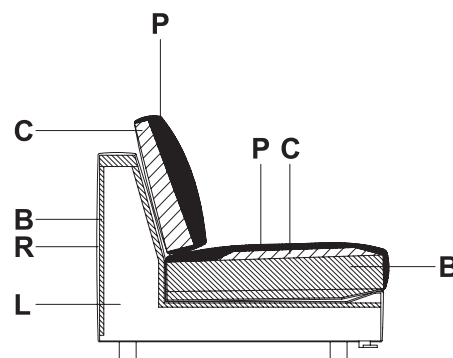

## Vibieffe

SINCE 1968

contact@vibieffe.com www.vibieffe.com

cod. 810001

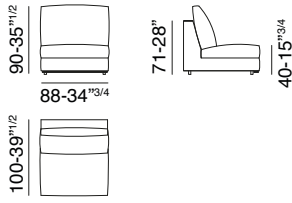

cod. 810002

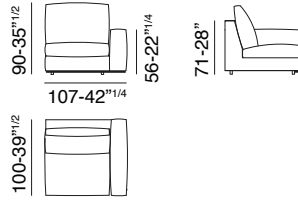

cod. 810003

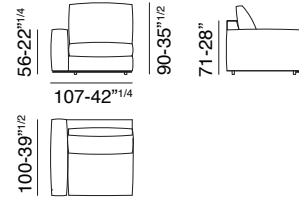

cod. 810004

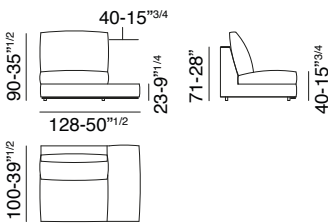

cod. 810005

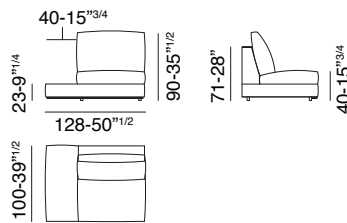

cod. 810006

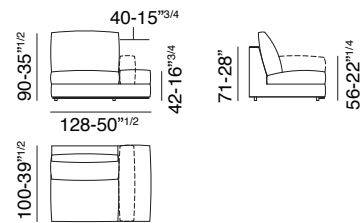

cod. 810007

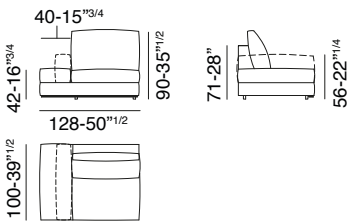

cod. 810008

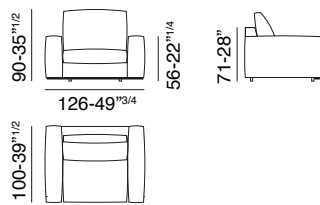

cod. 810009

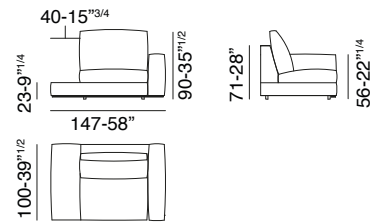

cod. 810010

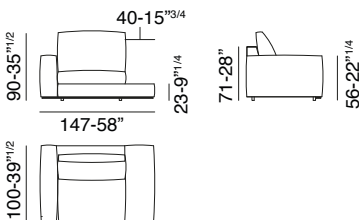

cod. 810011

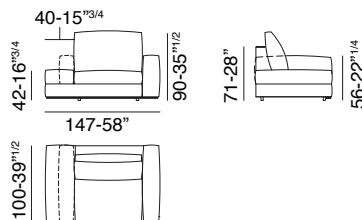

cod. 810012

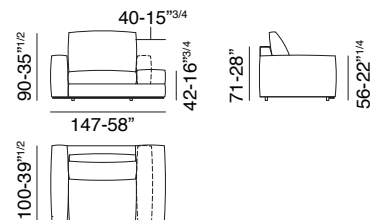

cod. 810013

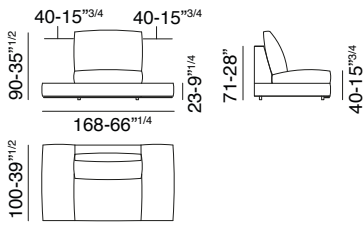

cod. 810014

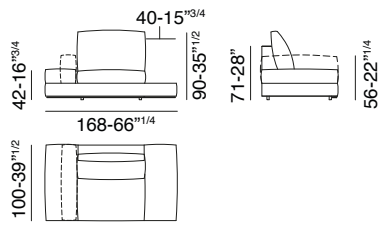

cod. 810015

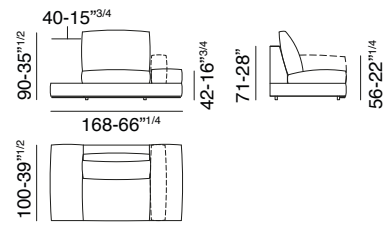

cod. 810016

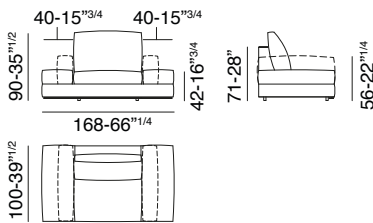

cod. 810017

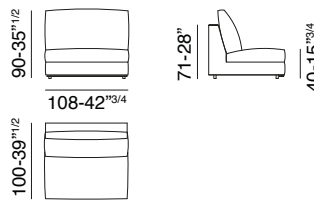

cod. 810018

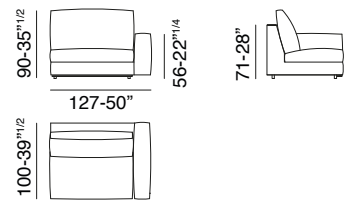

cod. 810019

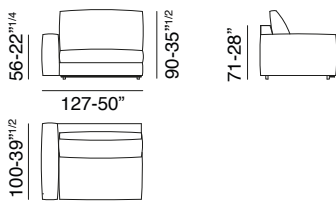

cod. 810020

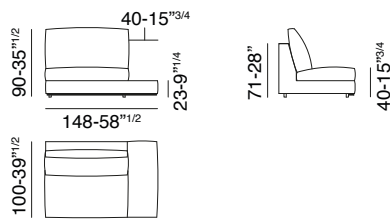

cod. 810021

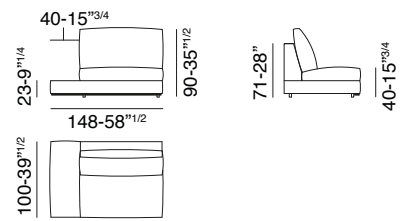

cod. 810022

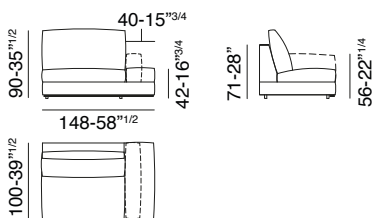

cod. 810023

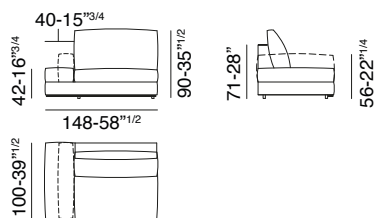

cod. 810024

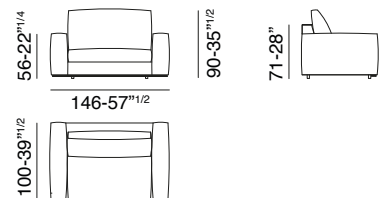

cod. 810025

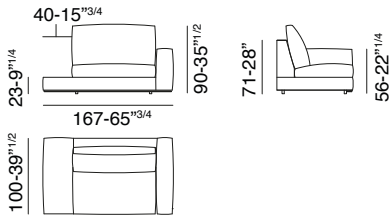

cod. 810026

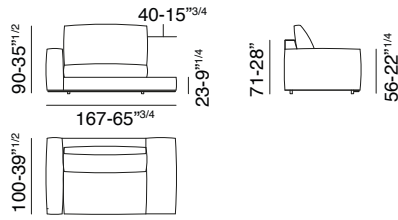

cod. 810027

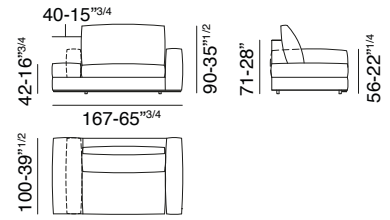

cod. 810028

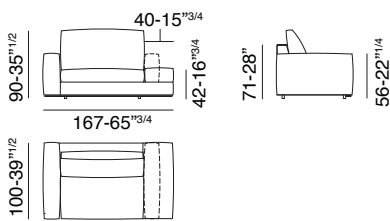

cod. 810029

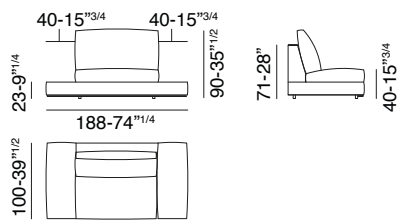

cod. 810030

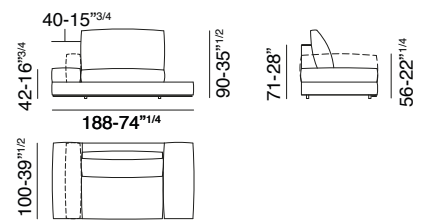

cod. 810031

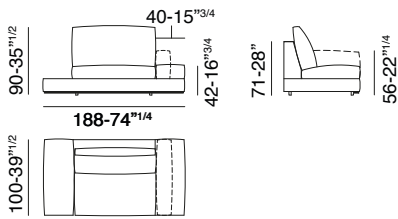

cod. 810032

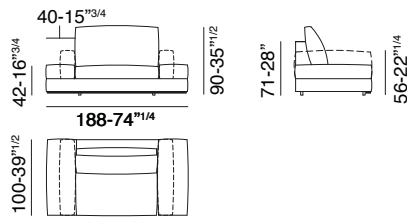

cod. 810033

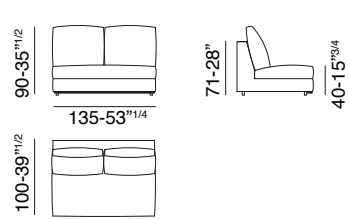

cod. 810034

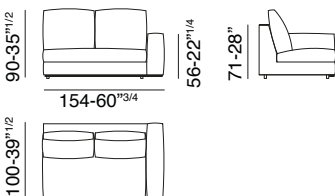

cod. 810035

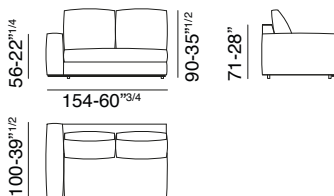

cod. 810036

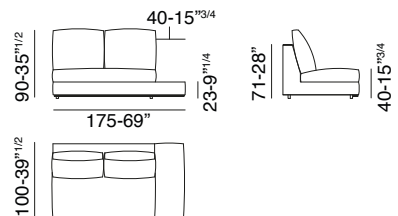

# 810\_FLY

design: Gianluigi Landoni

cod. 810037

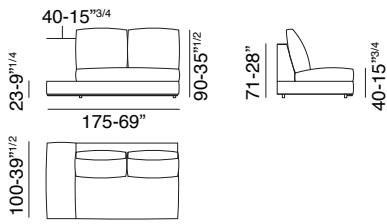

cod. 810038

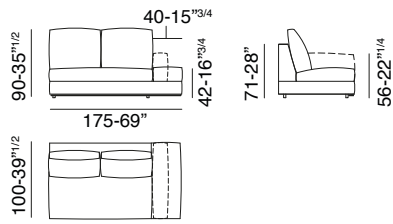

cod. 810039

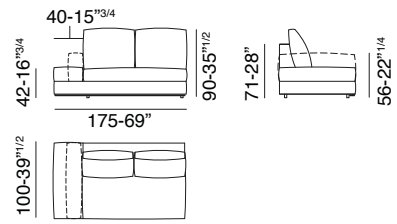

cod. 810040

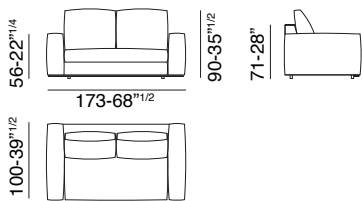

cod. 810041

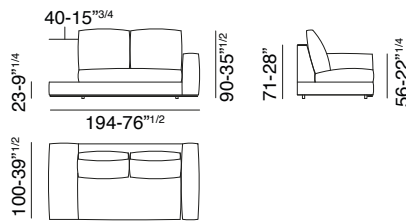

cod. 810042

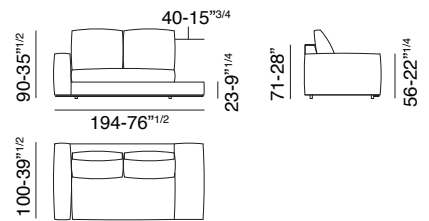

cod. 810043

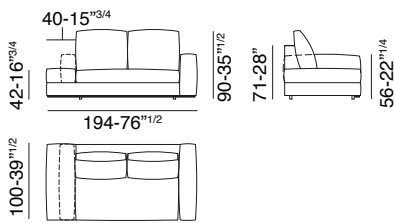

cod. 810044

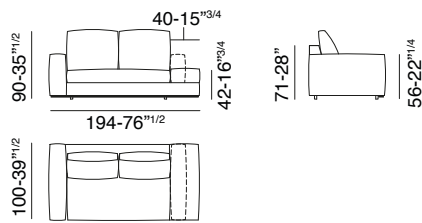

cod. 810045

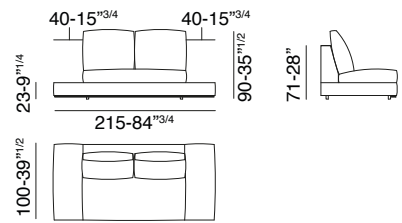

cod. 810047

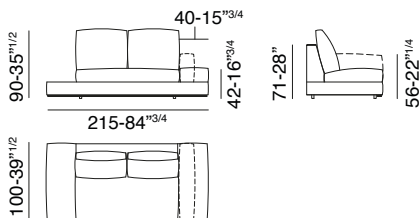

cod. 810046

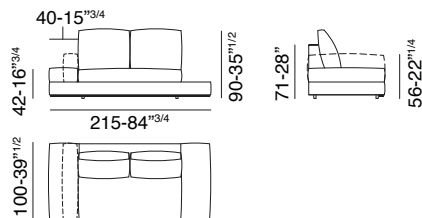

cod. 810048

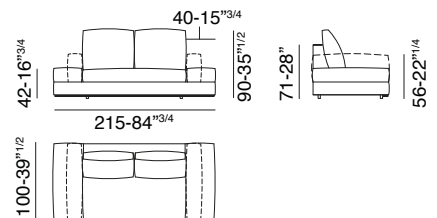

## Vibieffe

SINCE 1968

contact@vibieffe.com www.vibieffe.com

cod. 810049

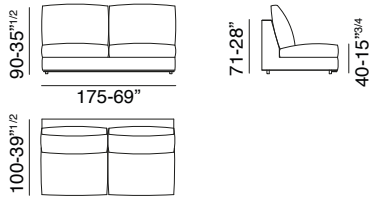

cod. 810050

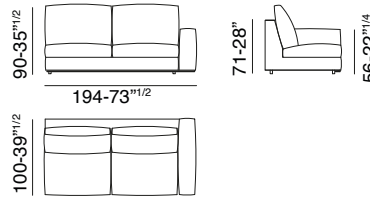

cod. 810051

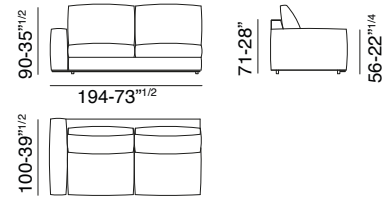

cod. 810052

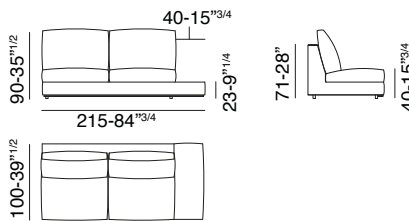

cod. 810053

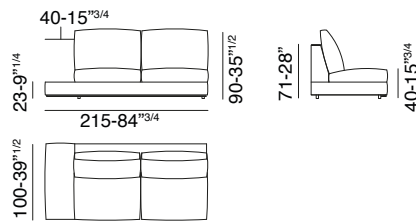

cod. 810054

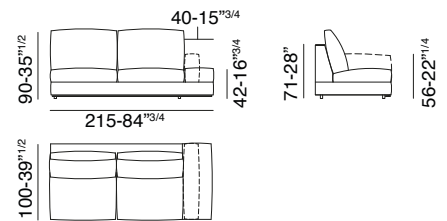

cod. 810055

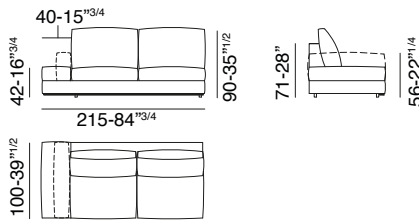

cod. 810056

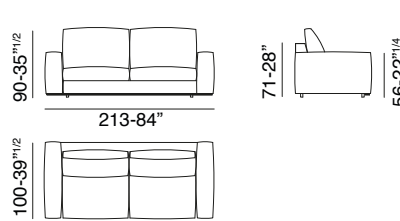

cod. 810057

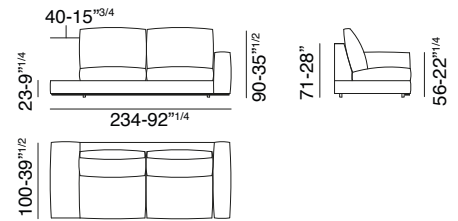

cod. 810058

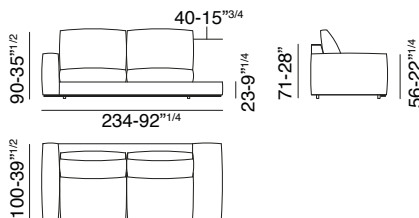

cod. 810059

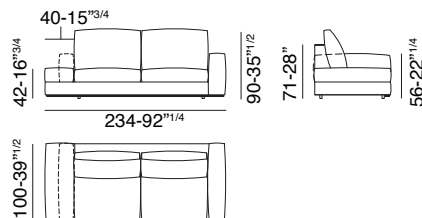

cod. 810060

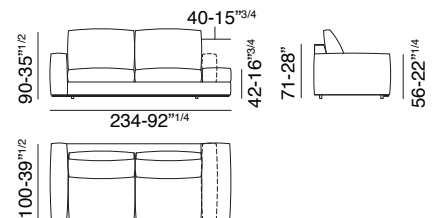

cod. 810061

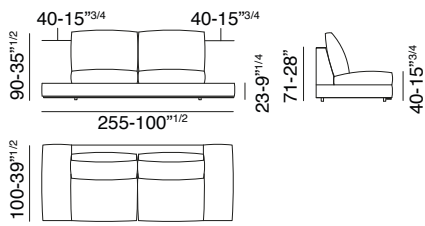

cod. 810062

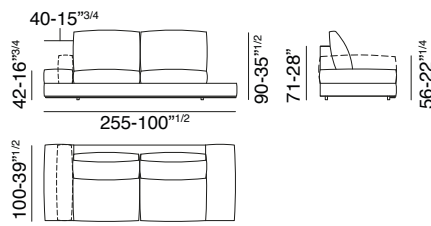

cod. 810063

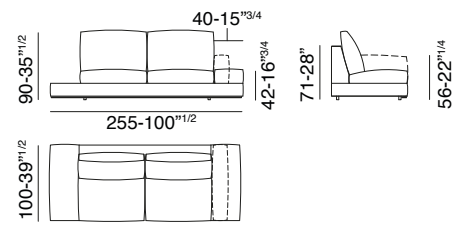

cod. 810064

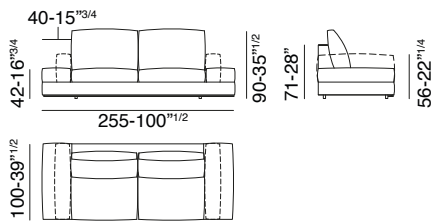

cod. 810065

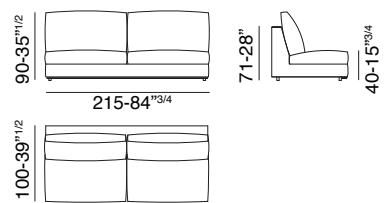

cod. 810066

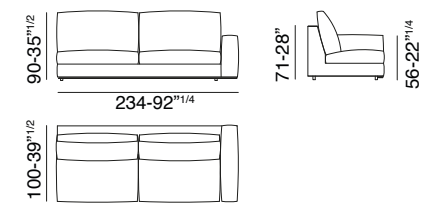

cod. 810067

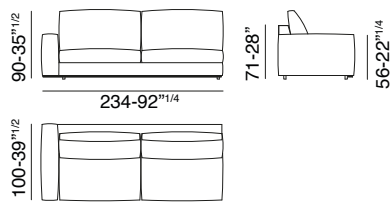

cod. 810068

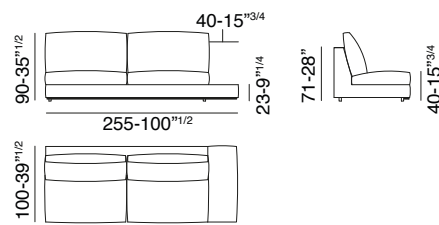

cod. 810069

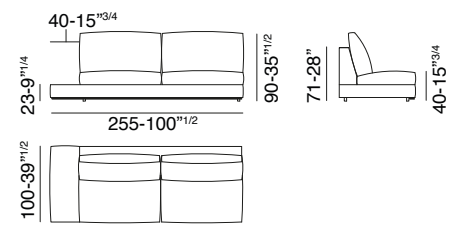

cod. 810070

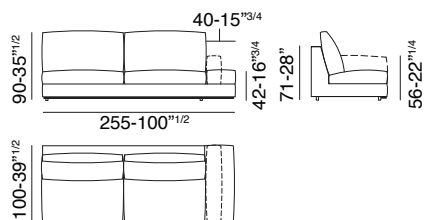

cod. 810071

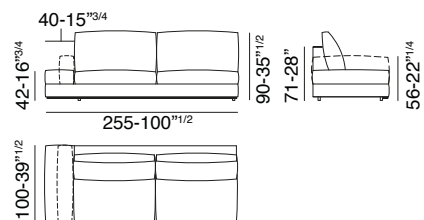

cod. 810072

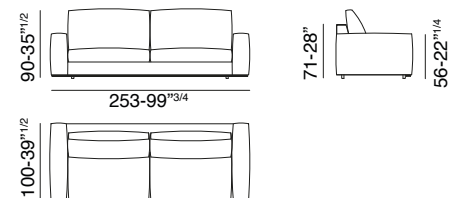



# 810\_FLY

design: Gianluigi Landoni

cod. 810073

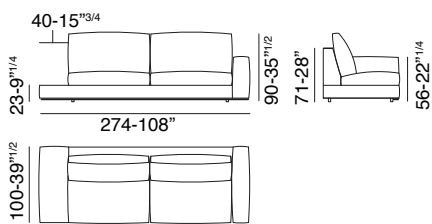

cod. 810074

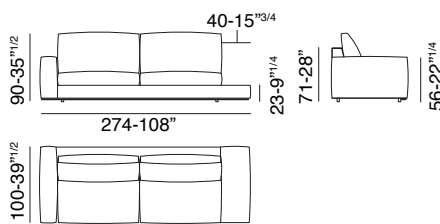

cod. 810075

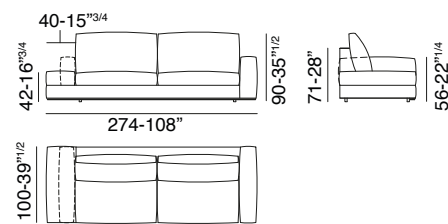

cod. 810076

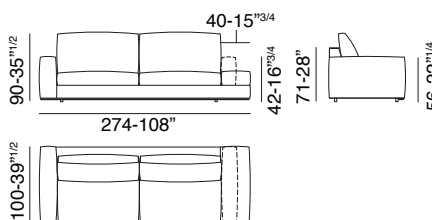

cod. 810077

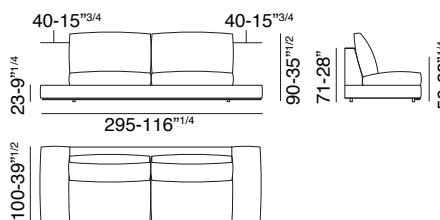

cod. 810078

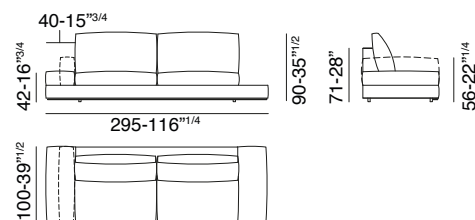

cod. 810079

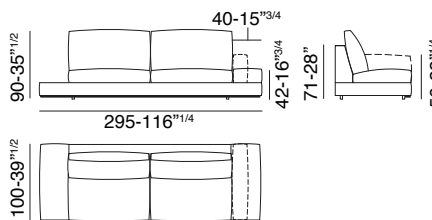

cod. 810080

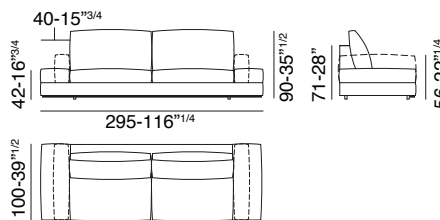

cod. 810081

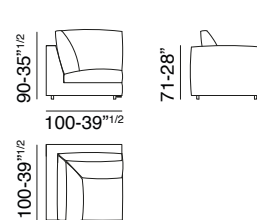

cod. 810082

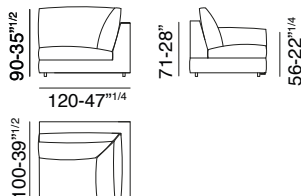

cod. 810083

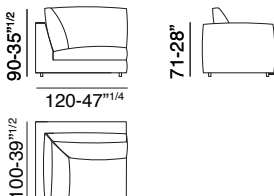

cod. 810084

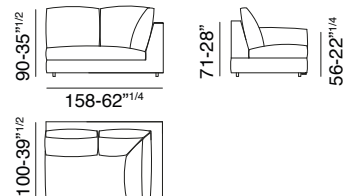

## Vibieffe

SINCE 1968

contact@vibieffe.com www.vibieffe.com

# 810\_FLY

design: Gianluigi Landoni

cod. 810085

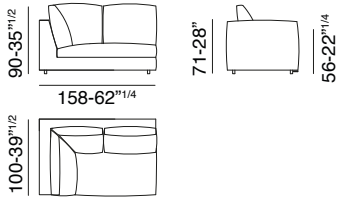

cod. 810092

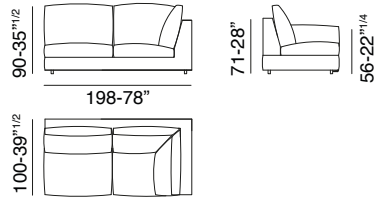

cod. 810093

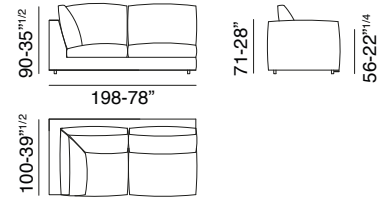

cod. 810100

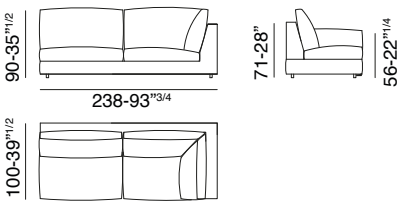

cod. 810101

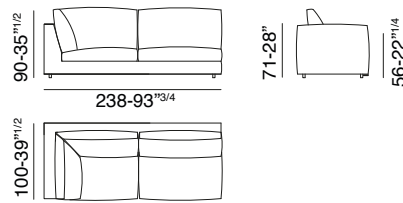

cod. 810108

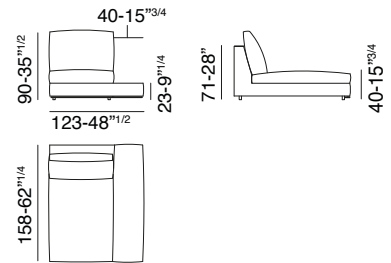

cod. 810109

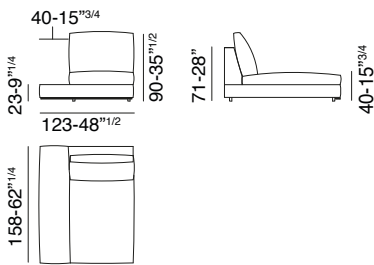

cod. 810110

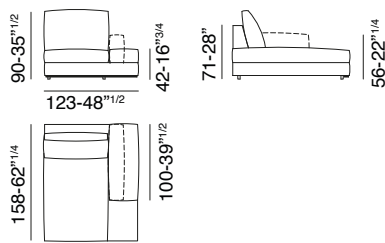

cod. 810111

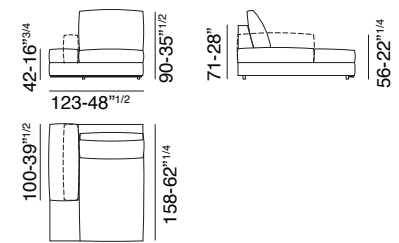

cod. 810112

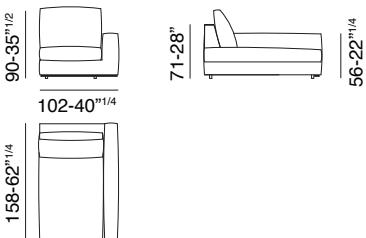

cod. 810113

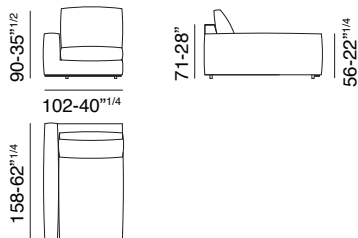

cod. 810114

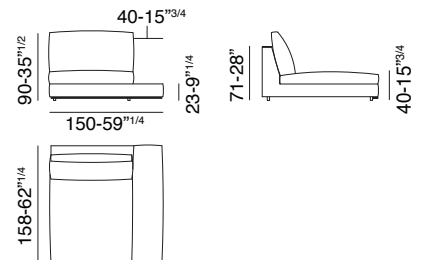

## Vibieffe

SINCE 1968

contact@vibieffe.com www.vibieffe.com

# 810\_FLY

design: Gianluigi Landoni

cod. 810115

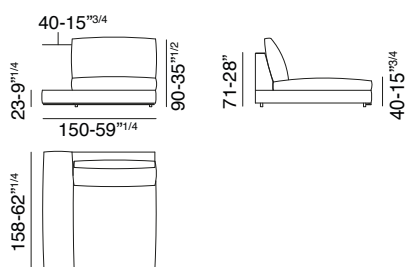

cod. 810116

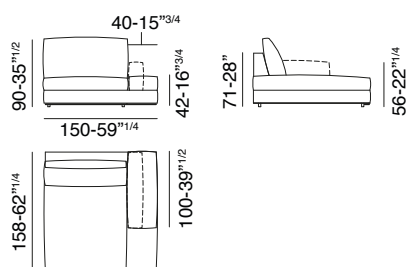

cod. 810117

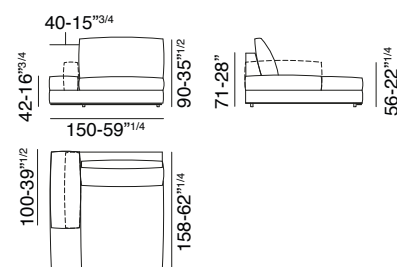

cod. 810126

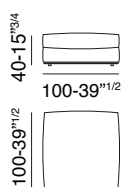

cod. 810127

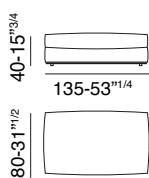

cod. 810128

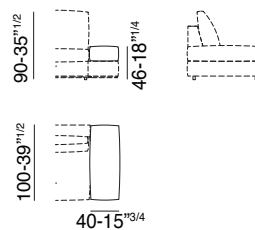

cod. 810129

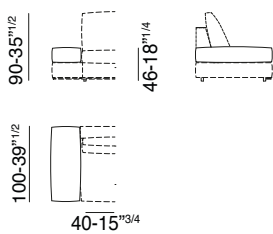

# Vibieffe

SINCE 1968

contact@vibieffe.com www.vibieffe.com

# 810\_FLY

---

design: Gianluigi Landoni

